

# DIAMOND MASK SEWING PATTERN

TO MAKE YOUR MASK YOU WILL NEED TO  
CUT THREE PATTERNS PLACED ALONG A FOLD

**OUTSIDE LAYER:** STURDY FABRIC: A REUSABLE SHOPPING BAG OR TEA TOWEL

**MIDDLE LAYER:** CALICO OR AN OLD SHIRT / BEDSHEET

**FACE LAYER:** SOMETHING SOFT: AN OLD T-SHIRT OR PILLOW CASE

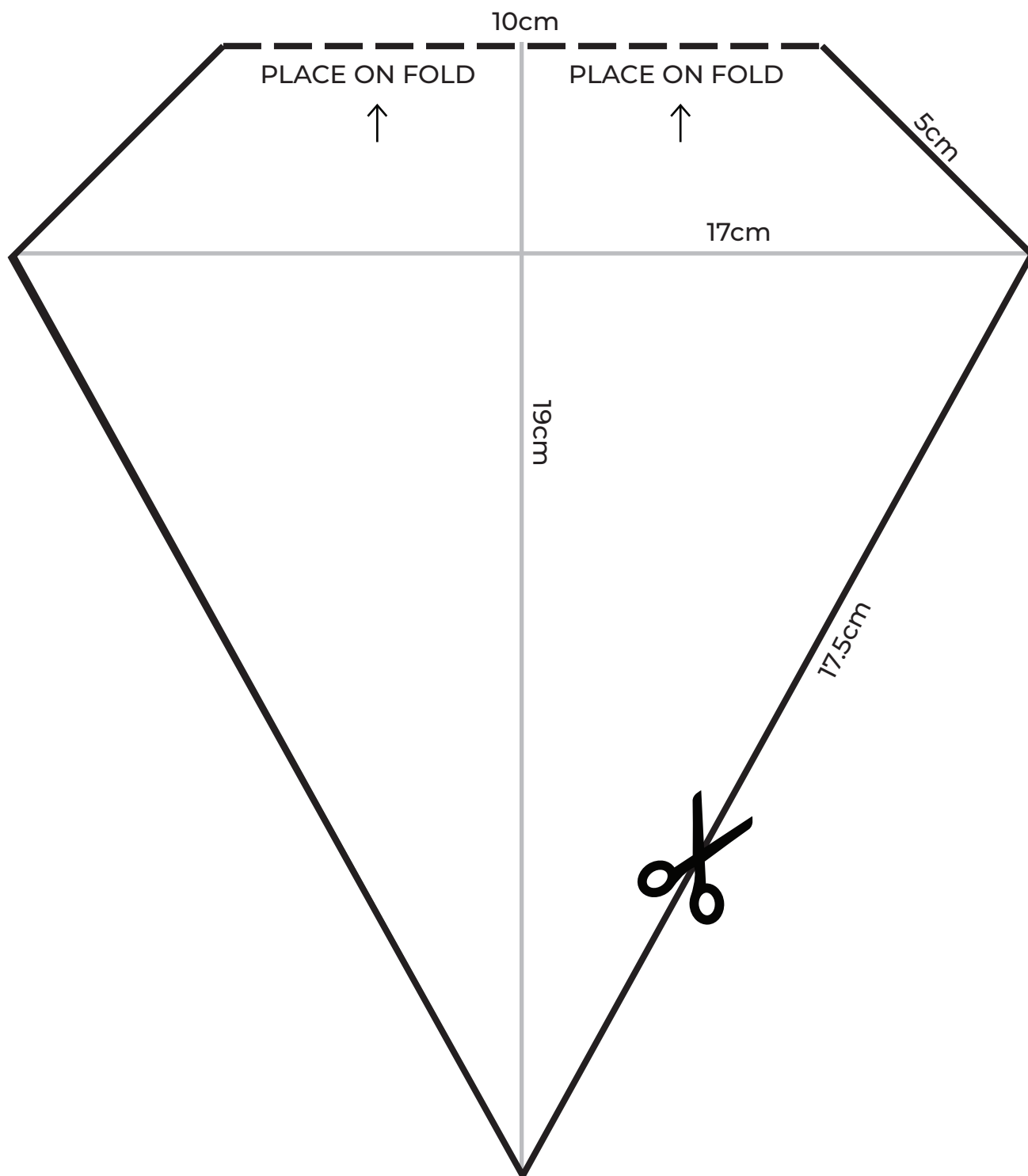

FOR THE 'CRAFTY CAL' VIDEO TUTORIAL, NO SEW MASK  
OPTIONS, AND OTHER SAFETY TIPS AND TRICKS  
HEAD TO: [THORNEHARBOUR.ORG/FACEMASKS](https://thorneharbour.org/facemasks)

# INSTRUCTIONS

CUT THREE DIAMOND PATTERNS WITH THE TOP EDGE ALONG THE FOLD

ARRANGE IN ORDER:

- MIDDLE LAYER
- ◐ FACE SIDE
- OUTER SIDE

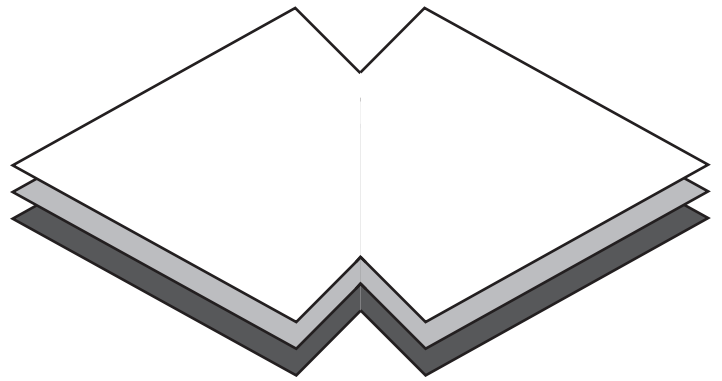

SEW EACH LONG EDGE LEAVING THE SMALLER EDGES FOR NOW.

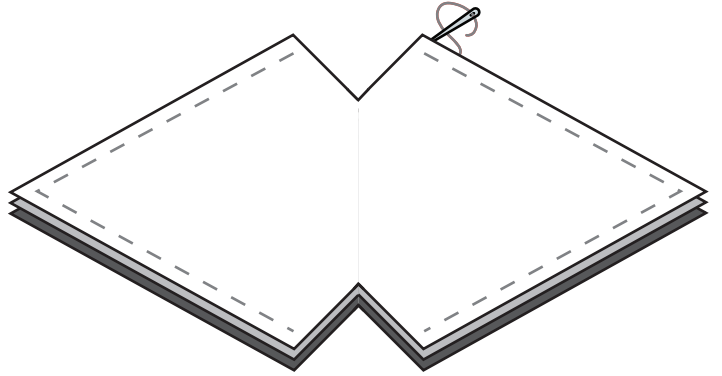

TURN INSIDE OUT USING OPEN SEAMS TO SHOW THE **FACE** AND **OUTSIDE** LAYER (THE MIDDLE LAYER SHOULD BE HIDDEN)

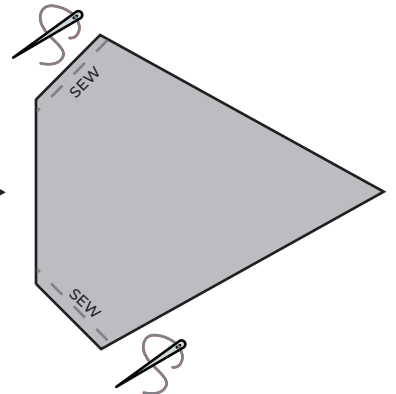
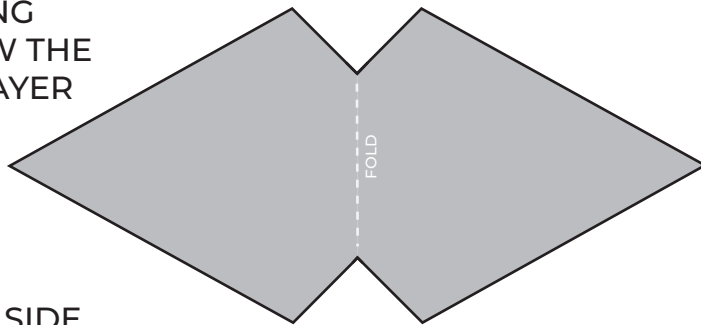

FOLD OUTSIDE LAYER TOGETHER. SEW FACE SIDE ALONG SHORT EDGES

PUSH OUT THE FOLD. PLACE FABRIC WITH **OUTSIDE** LAYER AGAINST YOUR SURFACE.

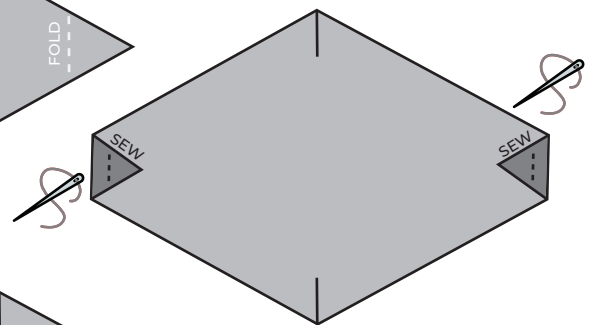
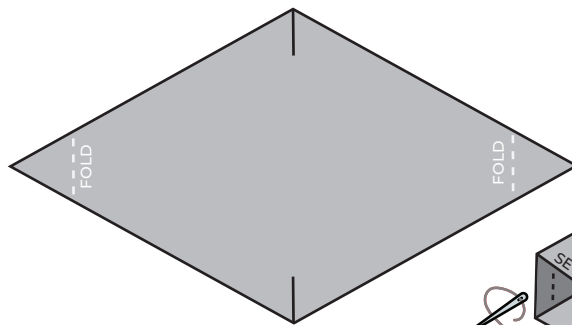

FOLD IN LEFT AND RIGHT POINTS INTO TABS ~2.5CM AND BACKSTITCH A FEW TIMES. YOU WANT THIS TO BE STURDY!

FINALLY THREAD STRING OR ELASTIC THROUGH THE TABS TO MAKE LOOPS FOR YOUR EARS.

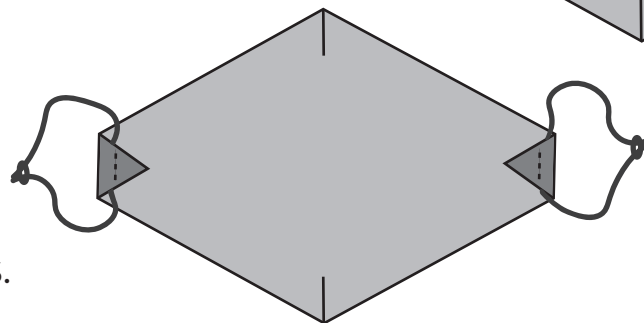

FOR THE 'CRAFTY CAL' VIDEO TUTORIAL, NO SEW MASK OPTIONS, AND OTHER SAFETY TIPS AND TRICKS HEAD TO: [THORNEHARBOUR.ORG/FACEMASKS](https://thorneharbour.org/facemasks)